

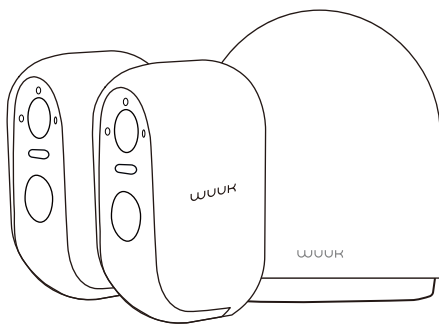

## Wireless Cam Pro Kit

# QUICK START



## WHAT'S INCLUDED

For WUUK Base Station

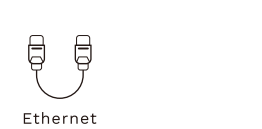
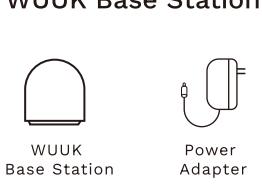

For WUUK Wireless Cam Pro

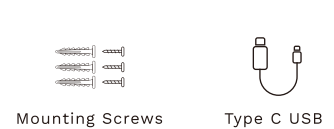
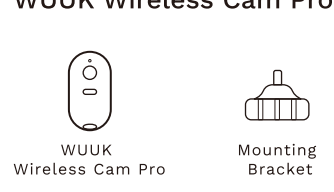

### Accessories

1. Brand Home Protection Stickers
2. User Manual
3. Tips for Alexa and Google Home Connection

\*Camera quantity and accessories vary by bundle package.  
 \*Base Station's power adapter varies by region.

## PRODUCT OVERVIEW

### WUUK Base Station

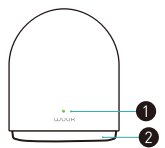

- Front**
- 1 Indicator light
  - 2 Speaker

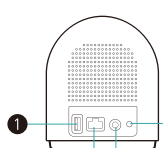

- Back**
- 1 USB port
  - 2 Ethernet port
  - 3 Power port
  - 4 SYNC button

### WUUK Wireless Cam Pro

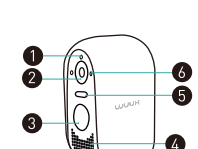

- 1 Indicator light
- 2 Camera lens
- 3 Motion sensor
- 4 Speaker
- 5 Spotlight
- 6 Microphone
- 7 Mounting hole
- 8 Charging port
- 9 Power/SYNC button

## CONNECTING WUUK BASE STATION TO THE INTERNET

Connect the WUUK Base Station with your WiFi router using the ethernet cable.

At this point, the indicator light on the WUUK Base Station turns blue, which indicates the system is initializing (this may take up to 1 minute).

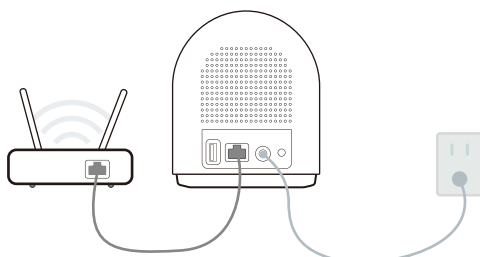

Once the initialization is completed, the indicator light on the WUUK Base Station turns green and gets ready for setup.

If the indicator light on the WUUK Base Station is red, it means no Internet access for the WUUK Base Station. Kindly check if the ethernet cable is correctly plugged in and if your WiFi router has Internet access.

## SETTING UP THE SYSTEM

### Getting the App and Setting up the System

Get the WUUK app before moving to setting up the WUUK Wireless Cam Pro.

Download the WUUK app from the App Store (iOS devices) or Google Play (Android devices).



Sign up for a WUUK account, then follow the onscreen instructions to complete the setup.

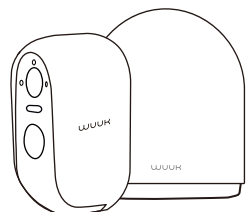

### WUUK Wireless Cam Pro

**Power on:** Long press the Power button, until you hear the device announces "Hello, WUUK".

**Power off:** Short press the power button 5 times, until the device makes 3 short beeping sounds.

**Entering pairing mode:** When the device is on, long press the power button for 3 seconds, until the device makes a short beeping sound and the indicator light is flashing red.

After the cameras are added to the WUUK Base Station, you can move to the next step "MOUNTING THE CAMERA".

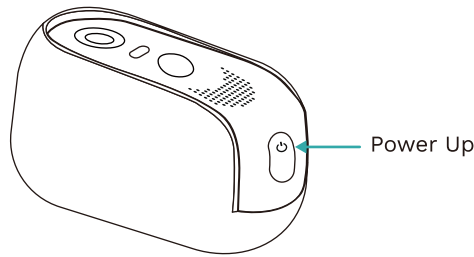

## MOUNTING THE CAMERA

### Find a Good Mounting Spot

Use the "Network Diagnosis" function in the WUUK app to test the wireless signal strength of the Wireless Cam Pro at the location you plan to mount the camera.

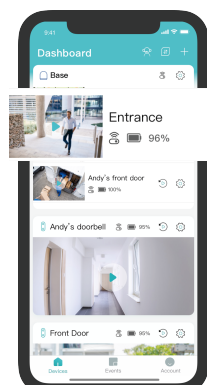

camera setting

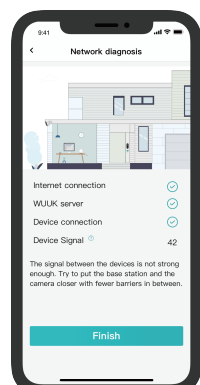

### Understand the Network Diagnosis Result

If the signal between the devices is not strong enough, please try to change the location of the camera until you find a spot that the camera and Base Station have a good signal testing result in the app.

### Height and Location

The camera can be mounted both indoors and outdoors.

We recommend hanging the WUUK Wireless Cam Pro 7-10ft (2-3m) above the ground. This height maximizes the detection range of the motion sensor on the WUUK Wireless Cam Pro.

Avoid placing the camera under direct sunlight.

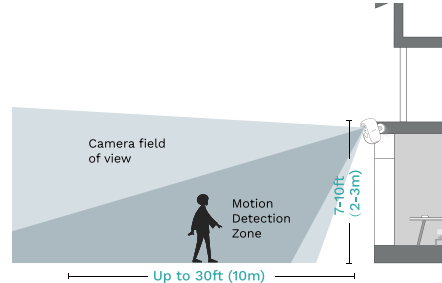

Turn the cover of the mounting bracket counterclockwise to loosen and disassemble it.

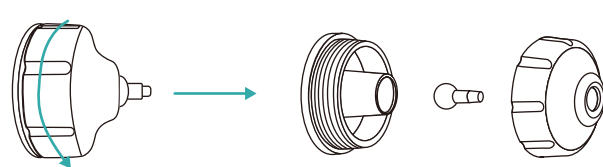

Use either the backplate of the mounting bracket to mark the location, or use the provided locating sheet in order to drill holes.

If you are installing on fibred materials such as wood, particle-board, you can directly install the backplate on using the screws provided.

Anchors are necessary for walls that are made out of hard materials such as concrete, brick, or stucco. In these cases, drill holes with a drill bit, then insert the anchors into the holes.

Recommended Drill Bit Size: 6mm

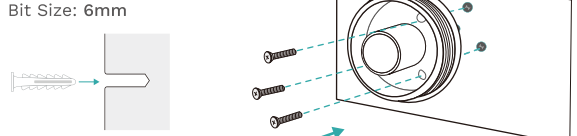

Firmly screw the backplate of the mounting bracket onto the wall. Turning the mount bracket cover clockwise to lock the ball knob stick to the backplate, and adjust the angle according to your needs.

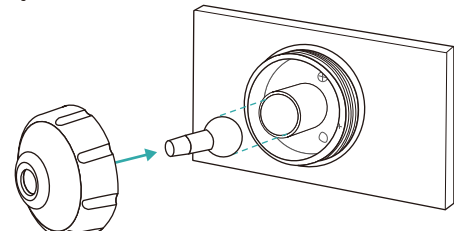

Attach WUUK Wireless Cam Pro to the mounting bracket, and turn the device clockwise to tighten.

Adjust the viewing angle by checking the live stream feed in the WUUK app before firmly locking every connecting knots.

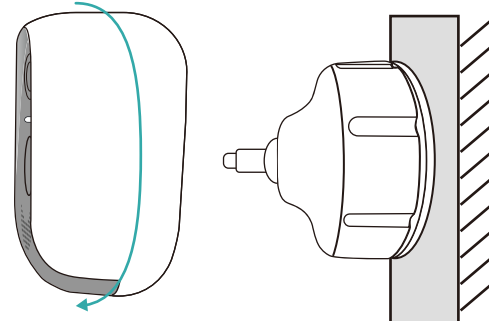

### Tips:

1. The WUUK Base Station pairs up to 8 cameras. You can repeat the steps mentioned above to add more WUUK Wireless Cam Pro to meet different needs of use.
2. For troubleshooting, check Account > Help Center on the WUUK app. Refer to app or the section "UNDERSTAND INDICATOR LIGHT".

## UNDERSTAND INDICATOR LIGHT

### WUUK Base Station

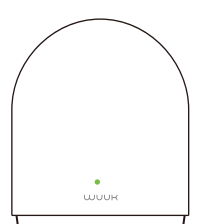

- Blue:** System is initializing
- Green:** Base Station is connected to the Internet
- Red:** Base Station is NOT connecting to the Internet
- Flashing Red:** Base Station is in pairing mode

### WUUK Wireless Cam Pro

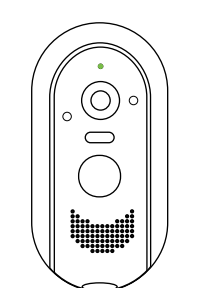

- Red:** Wireless Cam Pro is not connecting to the Base Station
- Flashing Red:** Wireless Cam Pro is in pairing mode
- Green:** Wireless Cam Pro's battery is fully charged
- Blue:** Wireless Cam Pro is being charged

## CHARGING YOUR WUUK WIRELESS CAM PRO

### Method 1

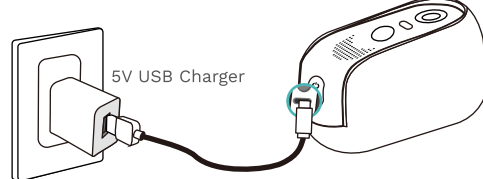

### Method 2

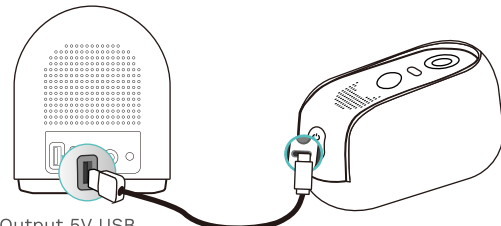

Wuuk Labs Corp. All rights reserved. WUUK and WUUK Logo are trademarks of Wuuk Labs Corp., registered in the United States and other countries. All other trademarks are the property of their respective owners.

Indicator Light	Charging: Blue ● Fully charged: Green ●
Charging Time	9 hours

## SAFETY STATEMENT

This device complies with Part 15 of the FCC Rules. Operation is subject to the following two conditions: (1) This device may not cause harmful interference. (2) This device must accept any interference received, including interference that may cause undesired operation.

FCC Warning Statement Changes or modifications not expressly approved by the party responsible for compliance could void the user's authority to operate the equipment. This equipment has been tested and found to comply with the limits for a Class B digital device, pursuant to Part 15 of the FCC Rules. These limits are designed to provide reasonable protection against harmful interference in a residential installation. This equipment generates uses and can radiate radio frequency energy and, if not installed and used in accordance with the instructions, may cause harmful interference to radio communications. However, there is no guarantee that interference will not occur in a particular installation. If this equipment does cause harmful interference to radio or television reception, which can be determined by turning the equipment off and on, the user is encouraged to try to correct the interference by one or more of the following measures:

- Reorient or relocate the receiving antenna.
- Increase the separation between the equipment and receiver.
- Connect the equipment into an outlet on a circuit different from that to which

the receiver is connected.

- Consult the dealer or an experienced radio/TV technician for help. FCC Radiation Exposure Statement

The antennas used for this transmitter must be installed to provide a separation distance of at least 20 cm from all persons and must not be co-located for operating in conjunction with any other antenna or transmitter.

## CUSTOMER SERVICE

### Warranty

12-month limited warranty

### Email Us

hello@wuuklabs.com

facebook.com/WUUKLabs

wuuklabs.com

### Work with Alexa & Google Home Setup Guide

